

Name: _____

Date: _____

Wave the Flag RHYMES

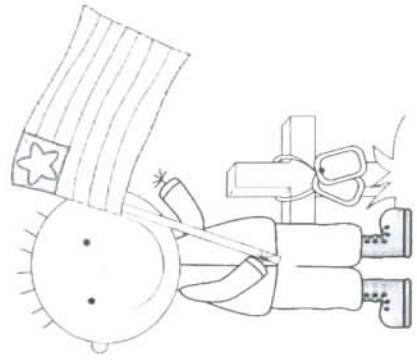

Circle the words that rhyme with flag.

bag

big

brag

bug

rag

rug

nag

dug

stag

wag

lag

fig

Name _____

Field Goal!







Cut.

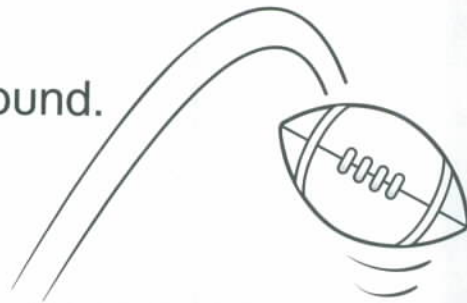

Glue to match the beginning sound.



begins like 			
begins like 			
begins like 			



BONUS: Draw a different picture for each beginning sound.

©The Mailbox® • Teacher's Helper® • TEC45069 • Oct./Nov. 2013

Name _____

Months of the Year

January



April



July



September

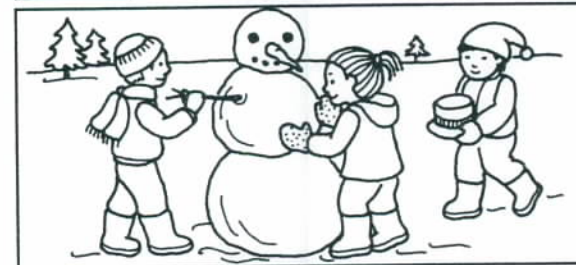

November



Directions: Have children say the name of each month listed here. Then have them draw a line to the picture that shows something people might do in that month.